

**EPON OLT**

**EPON Optical Line Terminal Equipment**

# **Installation User Manual**

V.1.3

<b>1</b>	<b>PRODUCT INTRODUCTION .....</b>	<b>2</b>
1.1	BRIEF INTRODUCTION.....	2
1.2	FUNCTIONAL FEATURES .....	2
1.3	APPEARANCE AND INTERFACE.....	3
<b>2</b>	<b>PRE-INSTALLATION PREPARATION .....</b>	<b>4</b>
2.1	POWER REQUIREMENT.....	4
2.2	EQUIPMENT GROUND .....	5
2.3	ROOM DESIGN REQUIREMENTS .....	5
<b>3.</b>	<b>HARDWARE INSTALLATION.....</b>	<b>5</b>
3.1	OPEN PACKAGE AND CHECKOUT .....	5
3.2	PRE-INSTALLATION PREPARATION .....	5
3.3	OLT INSTALLATION.....	6
3.3.1	<i>Plane stack installation</i> .....	6
3.3.2	<i>Rack Installation</i> .....	6
3.4	PORT AND CONNECTION.....	7
3.4.1	<i>Uplink Port</i> .....	7
3.4.2	<i>PON Port Connection</i> .....	9
3.4.3	<i>Ground Cable Connection</i> .....	9
3.4.4	<i>Management Port Connection</i> .....	9
3.4.5	<i>Power Supply</i> .....	11
3.5	OLT WORKING STATUS CHECKOUT.....	12
3.5.1	<i>Check out power supply</i> .....	12
3.5.2	<i>Check out OLT's working status</i> .....	13
3.5.3	<i>Check out ONU Registration</i> .....	13
3.5.4	<i>Network Connection Checkout</i> .....	13
3.5.5	<i>Network Management Checkout</i> .....	13
<b>5</b>	<b>DEFAULT CONFIGURATION.....</b>	<b>14</b>
5.1	NETWORK PARAMETER CONFIGURATION.....	14
5.2	CONSOLE PARAMETER CONFIGURATION .....	14
5.3	DEFAULT USERNAME AND PASSWORD .....	14
<b>6</b>	<b>APPENDIX : OLT SPECIFICATION .....</b>	<b>15</b>
<b>8</b>	<b>ENDING.....</b>	<b>16</b>

# 1 Product Introduction

## 1.1 Brief Introduction

The OLT is the latest EPON access product. It is the Pizza-Box OLT series products of 1U high 19 inch rack mount. The features of the OLT are small, convenient, flexible, easy to deploy, high performance. It is appropriate to deploy in an compact room environment . The OLT can use for “Triple-Play”, CPN, IP Camera, Enterprise LAN and IOT applications. It is a high cost performance products.

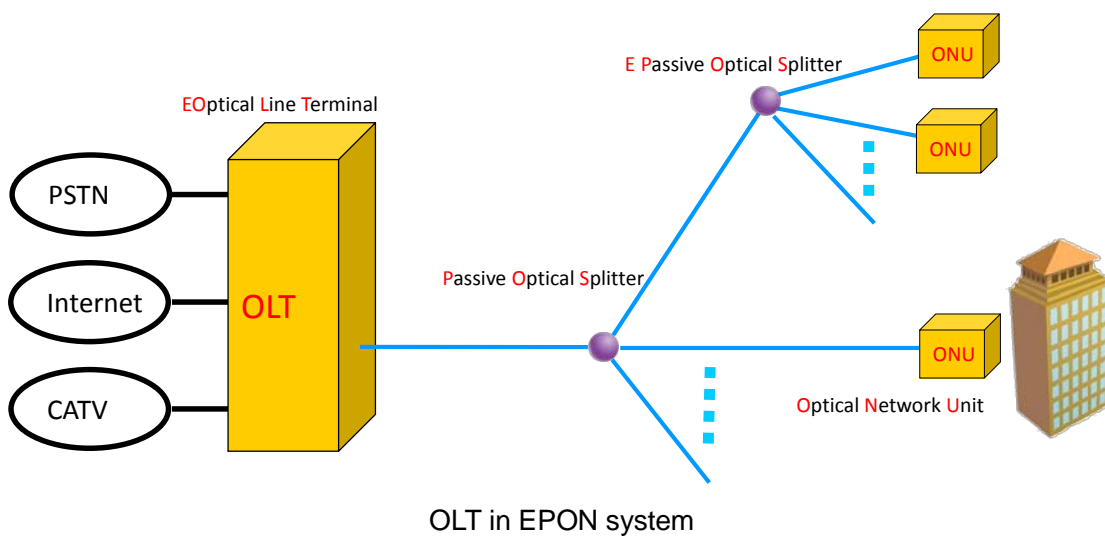

## 1.2 Functional Features

- Support 8 PON ports at most.
- Support 512 ONU (by 1:64 splitting ratio within 10km).
- provides 8GE(copper) and 8SFP slots Combo interface for uplink.
- Layer-two link rate switch.
- MAC Address Capacity: 16K
- VLAN supported number:4096
- ONU auto-detection and registration
- Dynamic bandwidth allocation.
- Support online upgrading and ONU batch upgrade.
- Management Interface: Support in-band and out-band management.
- Management Mode: CLI, TELNET,EMS
- Reliability: dual power redundant power supply

### 1.3 Appearance and Interface

The 1U high Pizza-Box OLT can be mounted into the standard 19" rack. Demission of machine frame: 442 mm (Length) x 315 mm (Width) x 44 mm (Height).

As shown below:

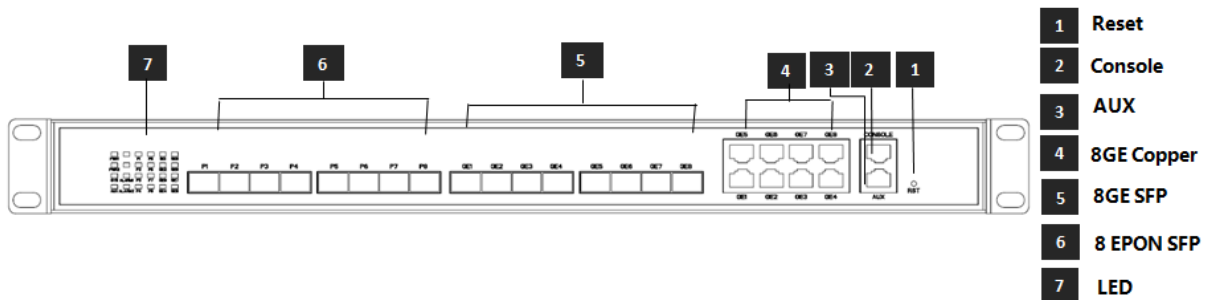

Front View of OLT

EPON OLT has 8 EPON SFP ports, 8GE(copper) and 8SFP slots Combo interface for uplink, 1 console port and 1 GE network management port. For details, see the following table.

Item		Specification
Uplink Port	Copper	10/100/1000M auto-negotiable,RJ45, 8pcs
	SFP	8 SFP slots (Combo)
PON Port	QTY	8
	Physical Interface	SFP Slots
	Connector Type	1000BASE-PX20
Management Ports		CONSOLE port—RJ45 connectors for local configuration
		AUX port (auxiliary port) ---RJ-45 connectors for Remote configuration
Reset Button		For reset the OLT

Please refer to Table about LED and button on the front panel of OLT .

Type	Identification	Status	Indication
Power supply indicator	PWR n ( n = 1/2 )	Green , Always ON	Normal Power supply
		OFF	Power supply is unconnected or breaks down
System status	SYS	Flash per second	System normally operate
Out-band management port	AUX	Flash	There is communication data at AUX port
		Green , Always	MGNT port is connected

		ON	
		OFF	MGNT port isn't connected
PON port indicator	P n ( n=1/2/3/4/5/6/7/8)	Flash	There is communication data at EPON port(n)
		Green , Always ON	There are ONU registered on OLT port(n) and the optical fiber link is normal.
		OFF	NO ONU link with the OLT port(n)
Uplink port indicator	GE n ( n=1/2/3/4/5/6/7/8)	Flash	There is the communication data at the uplink port(n)
		Green , Always ON	The uplink port(n) is connected
		OFF	The uplink port(n) isn't connected
Alarm	ALARM1		Reserved
	ALARM2		Reserved

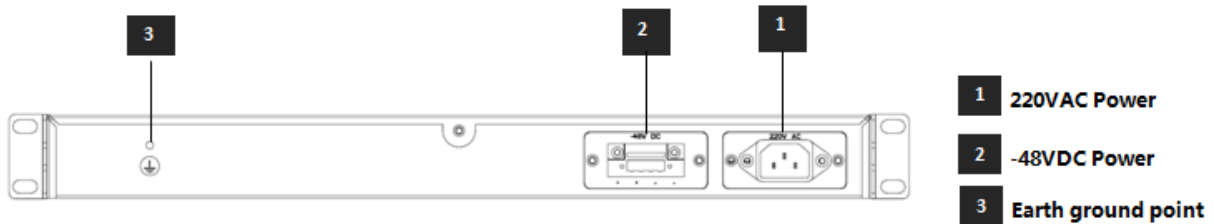

Back View of OLT

Item	Specification
Grounding Terminal	One, it's in the left of the front panel and is used to grounding for machine frame
Power supply slot	There are two slots for power supply. You can chose AC or DC power supply

## 2 Pre-Installation Preparation

### 2.1 Power Requirement

The input voltage must be stable, no EMI noise and distortion.

When use DC power supply, the input voltage is -48VDC, the allowed range is -36 ~ -72 VDC.

When use AC power supply, the input voltage is 110/220VAC, the allowed range is 90 ~ 264VAC.

**Note: Follow all security specification and the rule about the electricity in the locality or the building. All power supply must be legal.**

## 2.2 Equipment Ground

The grounding body must be configured in the machine room, the grounding resistance value is less than  $1\Omega$ . It can be realized by layout the anti-static copper mesh.

## 2.3 Room Design Requirements

The environment of the equipment operation has very big effect on its long-term reliable operation. Room design requests to up to the following standards:

- The device allows room temperature is  $0^{\circ}\text{C} \sim 40^{\circ}\text{C}$ . To ensure that equipment works in the normal temperature environment ( $25^{\circ}\text{C}$  or so), should try to make the equipment away from the main heat source (such as power supply, etc.), if the environment temperature is higher than  $40^{\circ}\text{C}$ , should try to improve the ventilated condition of the room, such as install fan in the frame or air conditioning in the room. The ventilation pipe in the room should be swept clean and ventilated, etc.;
- There must be the good cable wiring and go line space in the room. Cable and optical cable wiring (including fiber splicing work) are already in place.
- The related humidity  $10\% \sim 95\%$ , No condensation, no frost;
- The dust particles density with more than  $5\mu\text{m}$  in diameter is  $\leq 3.0 * 10^4/\text{m}^3$ ; Dust particles is a non-conductive, the non-magnetic and the non-corrosive;

# 3. Hardware Installation

## 3.1 Open package and checkout

According to the packing list or supply contract, check and verify the goods, if any component is loss, wrong or damaged, please contact with your customer manager.

The list includes the following content normally:

- 1 OLT Machine(1 Pcs)
- SFP modules are ordered according to user requirement
- AC power line or DC power line according to user requirement

## 3.2 Pre-installation Preparation

Verify the following working environment and installation requirements

1 Power Supply Requirement:

- DC power supply:  $-48\text{V DC}$ , the allowed range:  $-36\text{VDC} \sim -72\text{VDC}$

- AC power supply: 110/220V AC, the allowed range: 90 ~ 264VAC
- 2 The equipment should be equipped in the dry, cool place, at least have 10 centimeters at both sides for the ventilation space.
- 3 Avoid the direct light, far away from the heat source or the place with the stronger electromagnetic interference
- 4 If want to install OLT inside the rack, ensure that have the necessary mounting screws and nuts and necessary tools.
- 5 Check the required cable and connectors for installation
- 6 In the system management, need connect the following equipment with OLT:
  - A management platform, such as PC
  - RJ45/DB9 RS232 Console line

### 3.3 OLT Installation

OLT can be put in the bigger horizontal surface or within the standard EIA 19 " rack.

#### 3.3.1 Plane stack installation

Step I: Pre-Installation Validation

- Ensure the worktable is strong enough to support the weight of the device and cables.
- Ensure no obstacles on the worktable and the surroundings affecting the installation of the device exist.
- Prepare the OLT device to be installed and move the device to the place where is near the work table and facilitates the handling.

Step II: Lift the OLT device and slowly move to the front of the worktable.

Step III: Move the OLT device to the location slightly higher than the worktable and then place the OLT device to the specified location on the worktable.

#### 3.3.2 Rack Installation

OLT equipment can be installed inside 19" rack which is compliance with ETSI standard. OLT rack diagram as shown in below.

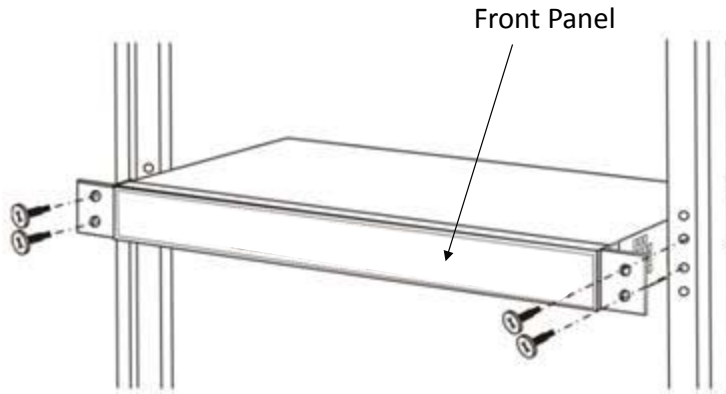

The installation process is as follows:

**Step I: Pre-Installation Validation**

- Ensure the cabinet is fixed and the installation location of the OLT device in the cabinet is well arranged, and no obstacles inside the cabinet and the surroundings affecting the installation of the device exist.
- Prepare the OLT device to be installed and move the device to the place where is near the cabinet and facilitates the handling.

Step II: Lift the OLT device and slowly move the device to the front of the cabinet.

Step III: Lift the OLT device to the location slightly higher than the tray or sideway of the cabinet, place the OLT device to the tray or sideway of the cabinet and then push it to the cabinet.

Step IV. Use screws to fix the suspension loops of the cabinet to the square holes of the 19-inch cabinet column and to fix the OLT device to the cabinet.

## 3.4 Port and Connection

The chapter describes the port and power supply connection situation in OLT system, mainly include the following parts:

- Uplink Port
- PON Port Connection
- Ground Cable Connection
- Management Port Connection

Please carefully read the following introduction before connecting each port of OLT:

### 3.4.1 Uplink Port

#### 3.4.1.1 Port Explanation

OLT offers eight GE (Copper) and eight GE SFP slot Combo interface for uplink.

To use the optical port, you need insert the SFP module to the port and then connect other Ethernet devices through the optical fiber cable. If the port is inserted with the SFP module, the corresponding electrical port cannot be used.



To use the electrical port, you can connect the electric port and other Ethernet devices with the direct-through or cross cable through the UTP port of the OLT. In this case, the corresponding optical port cannot be used.

SFP module can be the optical module or the electrical module, and follow standards below:

- 1000Base-LX (Long wave length)
- 1000Base-SX (Short wave length)
- 10/100/1000Base-T (Electrical port)

When use the single mode optical fiber, the maximum transmission distance can be up to 10-40km; when use the multimode fiber, the maximum transmission distance is less than 500 meters.

Gigabit Ethernet uplink port supports the duplex mode and flow control auto negotiation. But need note that the maximum length of the optical fiber is related with work mode of the optical fiber:

- Maximum length of 1000Base-LX fiber is depend on duplex mode
- Maximum length of 1000Base-SX fiber is the same in both full duplex and half duplex mode

### 3.4.1.2 Port Connection

There are two kinds of uplink network connection:

- Cable with RJ45 connectors at both sides
- Cable with LC connector at both sides

Decide the port type of OLT according to the port type of the uplink device (Switch or Route)

### 3.4.1.3 Method of making cable

If you use SFP optical module, cable specification: the optical cable with LC connector at both sides.

If you use GE copper interface, cable specification: Category 5 cable or Category5 super cable with RJ45 connector at both sides

The below the reference for making STP (Shielded Twisted-Pair) cable with RJ45connector at both sides



568-A Wiring

Pair #	Wire	Pin #
1-White/Blue	White/Blue	5
	Blue/White	4
2-White/Green	White/Green	1
	Green/White	2
3-White/Orange	White/Orange	3
	Orange/White	6
4-White/Brown	White/Brown	7
	Brown/White	8

**< 568-A Diagram**

### 3.4.2 PON Port Connection

OLT support eight EPON SFP slots, every SFP EPON slots can mount a EPON SFP module and provides one PON port.

**Caution:** When insert into optical cable, please confirm the connector is inserted into the correct position, thus guarantee the good contract.

SFP PON slots installs standard 1000BASE-PX20 OLT SFP .The OLT SFP interface is SC/PC. Please use the patch cord with SC/PC connector to connect between the OLT and the ODN networking .

### 3.4.3 Ground Cable Connection

Ensure the safety and reliable working of OLT. OLT should be connected with the ground if necessary. Grounding screws are located in the rear panel. While connecting, you should use screwdriver to loosen the grounding screw first, then connect the ground cable, finally tighten the screws.

### 3.4.4 Management Port Connection

OLT equipment provides console interface (marked as “CONSOLE” RJ45 type port) and out-band management internet access (marked as “AUX” RJ45 type port).

Console access is really only required when initially configuring a device, or if remote access fails.

Console access requires:

- Console cable: RJ-45-to-DB-9 console cable
- Terminal emulation software: HyperTerminal

The cable is connected between the serial port of the host and the console port on the device. Most computers and notebooks no longer include built-in serial ports. If the host does not have a serial port, the USB port can be used to establish a console connection. A special USB-to-RS-232 compatible serial port adapter is required when using the USB port.

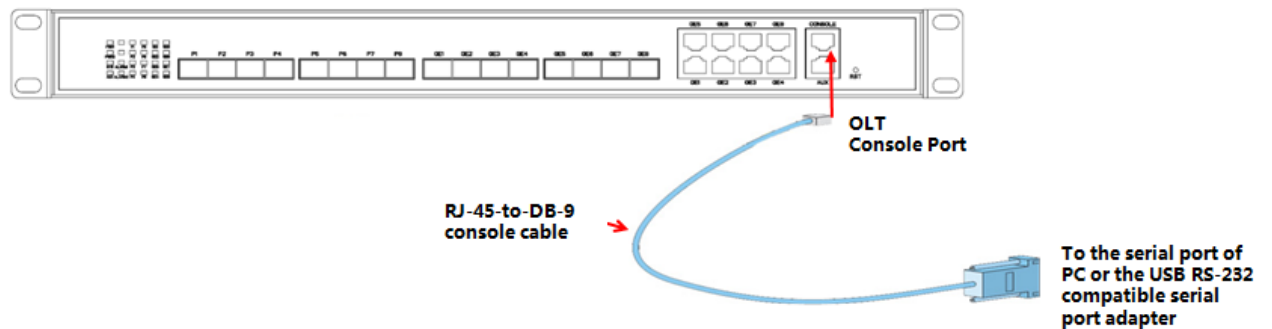

Port on Computer	Cable Required	Port on OLT
Serial Port	RJ-45 to DB-9 Console Cable	RJ-45 Console Port
USB Type-A Port	<ul style="list-style-type: none"> <li>● USB to RS-232 compatible serial port adapter ( Adapter may require a software driver )</li> <li>● RJ-45 to DB-9 Console Cable</li> </ul>	



RJ-45 to DB-9 Console Cable



USB to RS-232 compatible serial port adapter

When starting the out-band management, please use straight and cross Ethernet cable, connecting “MANAGE” out-band management interface to network or managed PC.

## 3.4.5 Power Supply

### 3.4.5.1 Connecting the AC Power Cable

The two AC power supply units in the OLT allow for 1 + 1 power redundancy. If one power supply unit fails, then the system will continue to operate using the remaining power supply unit. Additionally, to ensure true AC line input redundancy for the OLT, you should connect each AC power cable to a different AC power source. You can also connect an uninterruptible power supply (UPS) between each AC power source and the server to increase the availability of the server.

1. Get the supplied AC power cords from the OLT's shipment kit.
2. Connect one end of each AC power cord into the AC power inlet connectors located at the rear of the server.
3. Connect the other ends of the power cords into AC wall outlets. Connect each AC power cord to a different AC power source if you want AC line input power redundancy.

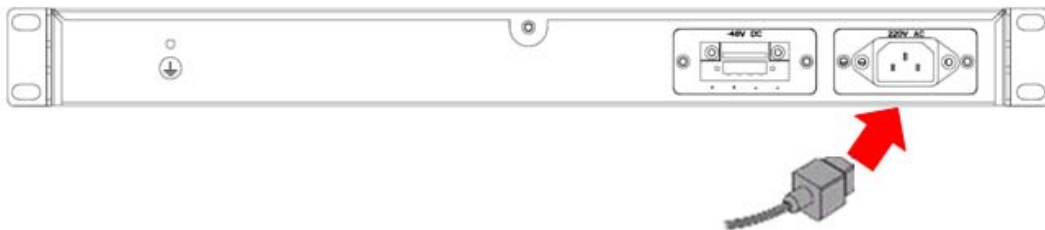

### 3.4.5.2 Connecting the DC Input Power Cable

1. Identify the parts that you will use to assemble the DC input power cable  
The following DC connection cable is required to assemble one or more DC power input cables. These cables connect the -48V DC input source(s) to the power supply units.
2. Turn off power from the DC power source through the circuit breakers.  
*Caution - Do not proceed with these instructions until you have turned off the power from the DC power source through the circuit breakers.*
3. Get a DC input plug from the ship kit.
4. Locate the four wires coming from the DC power source that will be used in the connection to your unit::
  - 48V (negative terminal) (two wires)
  - 48V Return (positive terminal) (two wires)
5. Strip 5/16 inches (8 mm) of insulation from each of the wires coming from the DC power source.

Do not strip more than 5/16 inches (8 mm) from each wire. Doing so leaves un insulated

wire exposed from the DC connector after the assembly is complete.

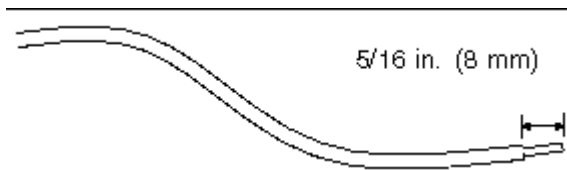

6. Feed the exposed section of the appropriate wire into the rectangular plug hole in the DC input plug. The diagram shows which wires should be inserted into each hole in the DC input plug.

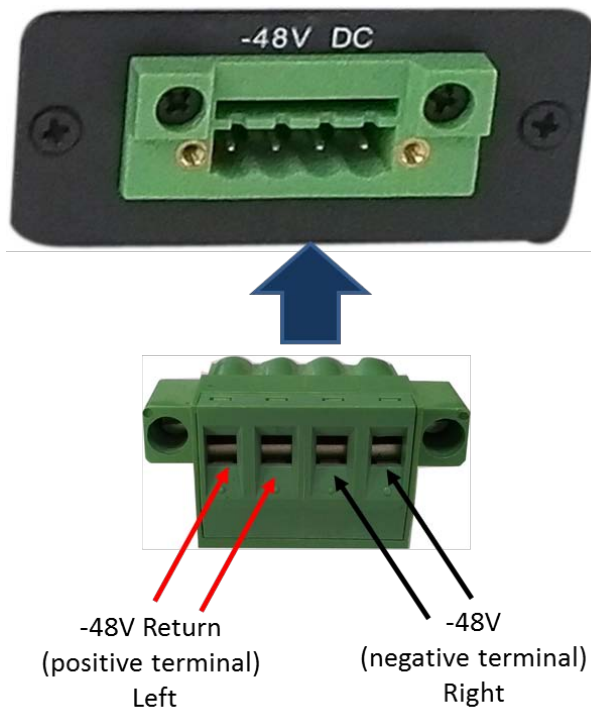

8. Repeat Step 5 and Step 7 for the other two wires to complete the assembly of the DC input power cable.
9. Connect the DC input power cables to the DC connectors

### 3.5 OLT working status checkout

#### 3.5.1 Check out power supply

Before you connect the power supply, double check the power supply if it is accord with the power supply requirements, If each module and card are installed correctly , If the equipment is in reliable grounding or not. After checking everything is OK, you can turn on the power supply sources.

### 3.5.2 Check out OLT's working status

Please check if the OLT's working status from following aspects:

- Check the power LED. The power LED will be on.
- The SYS LED will flash per second
- If the uplink equipment is connected to the uplink port, the relevant connection LED is on.

### 3.5.3 Check out ONU Registration

In default situation, there is no need any configuration after you turn on the equipment . ONU equipment can be registered after connected with the PON port of OLT.

Before starting access the equipment, please use optical power meter to measure the optical power of PON port, and check if it's in equipment specification range.

Using one ONU correctly connecting with any PON port of OLT, check if this ONU can be registered to OLT by means of the ONU's LED working status, once the ONU is successfully registered, the "Pr" LED close to PON port of OLT should be on.

### 3.5.4 Network Connection Checkout

In the case of default configuration, the network of users could communicate with OLT when ONU registers with OLT.

Connect a PC with an ONU UNI port and check if the network is running well by means of ping LAN (in the same IP address) or by PING package tools.

### 3.5.5 Network Management Checkout

Local Command Line Interface Management:

Use the RJ45/DB9 Serial Port cable (in package) to link management PC with OLT CONSOLE port. Management computer can access to OLT equipment from Super terminal interface of the PC for configuration..

In Band and out band Management

Use PC which has installed EMS network management software to connect in band or out band port of OLT. EMS network management can visit OLT after adding the olt into EMS interface. The icon of OLT shows green, and its PON card is also green. Icon of ONU which register to OLT is green under EMS interface as well.

You also can telnet the OLT by inband and outband.

***※Please refer to relevant CLI user manual if you want to know more about command management, and refer to EMS network management configuration user manual to know more about EMS network management functions and operations***

## 5 Default Configuration

### 5.1 Network Parameter Configuration

Out Band Network Port (uplink port on switch control card)

IP Address: 192.168.1.100

Subnet Mask: 255.255.255.0

Default Gateway: 192.168.1.1

Read community: public

Write Community: private

In Band Network Port

IP Address: 192.168.1.100

Subnet Mask: 255.255.255.0

Default Gateway: 192.168.1.1

Read community: public

Write Community: private

### 5.2 CONSOLE Parameter Configuration

Band Rate: 9600

Data Bit: 8

Parity Check: NO

Stop Bit: 1

Flow Control: NO

### 5.3 Default Username and Password

Local Command Line

Username: admin

Password: admin

SNMP Access

Read Community: public

Write Community: private

## 6 Appendix : OLT Specification

Item		OLT
Chassis	Rack	1U 19 inch standard box
	Slots	NA
Uplink Port	QTY	16
	Copper	10/100/1000M auto-negotiable,RJ45:8pcs
	SFP	8 SFP slots (Combo)
PON Port	QTY	8
	Physical Interface	SFP Slots
	Connector Type	1000BASE-PX20
	Max splitting ratio	1:64
Management Ports		1*100BASE – TX outband port 1 CONSOLE port
PON Port Specification	Transmission Distance	20KM
	PON port speed	Symmetrical 1.25Gbps
	Wavelength	1490nm TX,1310nm RX
	Connector	SC/PC
	Fiber Type	9/125µm SMF
	TX Power	+2~+7dBm
	Rx Sensitivity	-27dBm
	Saturtion Optical Powr	-6dBm
Management Mode		SNMP, Telnet, and CLI management mode.
Management Function		Fan Group Detecting Port Status monitoring and configuration management; Layer-2 switch configuration such as Vlan, Trunk ,RSTP,IGMP ,QOS, etc; EPON management function: DBA ,ONU authorization, ACL ,QOS ,etc; Online ONU configuration and management User management Alarm management
Layer-two Switch		Support port Vlan and protocol Vlan Support Vlan tag/Untag ,vlan transparent transmission; Support 4096 VLAN Support 802.3dd trunk RSTP QOS based on port ,VID,TOS and MAC address IGMP Snooping 802.x flow control Port stability statistic and mornitoring
EPON Function		Support port-based rate limitation and bandwidth control;



		<p>In compliant with IEEE802.3ah Standard</p> <p>Up to 20KM transmission Distance</p> <p>Support data encryption, group broadcasting, port Vlan separation ,RSTP,etc.</p> <p>Support Dynamic Bandwidth Allocation (DBA)</p> <p>Support ONU auto-discovery/Link detection/remote upgrade of software;</p> <p>Support VLAN division and user separation to avoid broadcast storm;</p> <p>Support various LLID configuration and single LLID configuration .Different user and different service could provide different QoS by means of different LLID channels.</p> <p>Support power-off alarm function ,easy for link problem detection</p> <p>Support broadcasting storm resistance function</p> <p>Support port isolation between different ports</p> <p>Support ACL and SNMP to configure data packet filter flexibly</p> <p>Specialized design for system breakdown prevention to maintain stable system</p> <p>Support dynamic distance calculation on EMS online</p> <p>Support RSTP,IGMP Proxy</p>
Dimension		442mm(L)*315mm(W)*44mm(H)
Weight		4.5kg
Power Supply	220VAC	AC: 90V~240V, 47/63Hz
	-48DC	DC:-36V~-72V
Power Consumption		48W
Operating Environment	Working Temperature	-10~45℃
	Storage Temperature	-40~85℃
	Relative Humidity	5~90%(non-conditioning)

## 8 Ending

Thanks very much for deploying our equipment.

Should have any doubt or problem to know about our products installation, please don't hesitate to contact us.